

► SKIMMER 15 L PISCINA HORMIGÓN / SKIMMER 15 L CONCRETE POOL

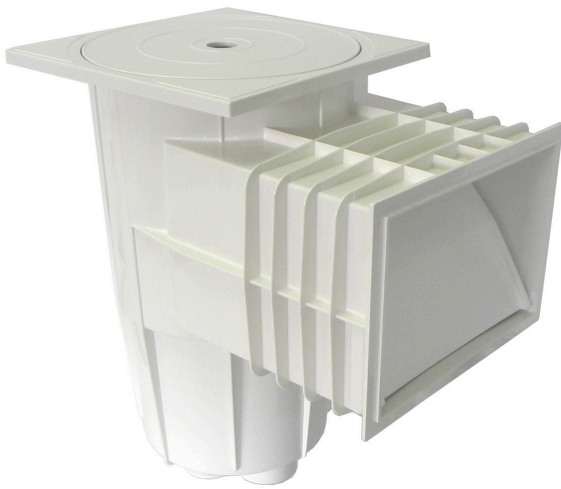

00250



00251

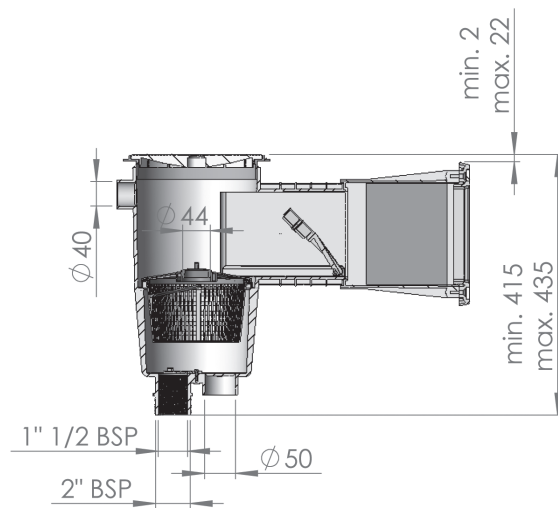
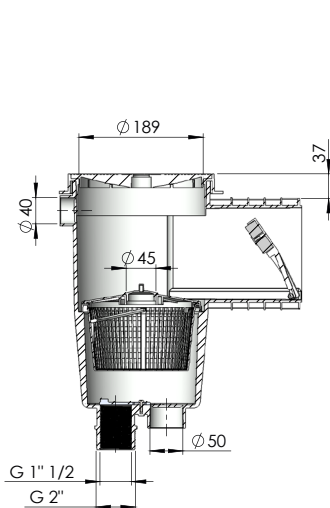
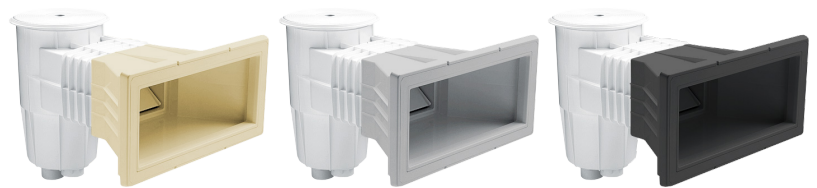
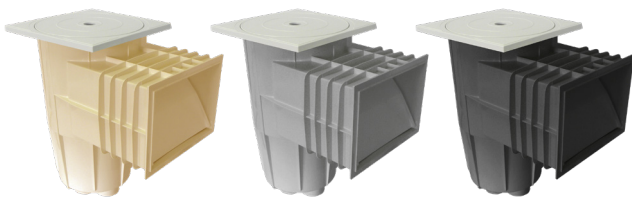

























DESCRIPCIÓN DEL PRODUCTO / PRODUCT DESCRIPTION

Todos los skimmers de la gama tienen tratamiento UV en las partes que no quedan enterradas. Fabricados en ABS blanco, con flotador de compuerta y clapeta para regulación de caudal. Conexión inferior de aspiración: rosca int. 1 1/2", ext. 2". Conexión simultánea al sumidero: Ø int. 50. Conexión superior de evacuación de agua sobrante Ø 40. Cesto recogehojas. Caudal recomendado 5 m³/h. Se recomienda instalar un skimmer por cada 25 m² de superficie de lámina de agua.

All exposed skimmer parts are UV resistant. In white ABS with silent wier flap and flow regulation plug. 1 1/2" female - 2" male suction connections. Ø 50 mm solvent connection also provided. Overflow connection Ø 40 mm. Basket secured to base with bayonet fixing. Recommended flow 5 m³/h. We recommend installing one skimmer for every 25 m² of water surface area.

► CARACTERÍSTICAS TÉCNICAS / TECHNICAL CHARACTERISTICS

CARACTERÍSTICAS / CHARACTERISTICS	00249	00250	00251	00252
Tipo de boca <i>Type of throat</i>				
Forma tapa <i>Lid form</i>				
Rosca int. (conexión inferior) <i>Thread int. (bottom connection)</i>	1 1/2"	1 1/2"	1 1/2"	1 1/2"
Rosca ext. (conexión inferior) <i>Thread ext. (bottom connection)</i>	2"	2"	2"	2"
Conexión superior <i>Top connection</i>	Ø 40	Ø 40	Ø 40	Ø 40
Caudal recomendado <i>Recommended flow rate</i>	5 m ³ /h	5 m ³ /h	5 m ³ /h	5 m ³ /h
Superficie recomendada <i>Recommended surface</i>	cada 25 m ² <i>every 25 m²</i>	cada 25 m ² <i>every 25 m²</i>	cada 25 m ² <i>every 25 m²</i>	cada 25 m ² <i>every 25 m²</i>
Colores <i>Colours</i>	  CL090  CL129  CL144	  CL090  CL129  CL144	  CL090  CL129  CL144	  CL090  CL129  CL144

► LOGÍSTICA / LOGISTICS

EMBALAJE Y PALETIZADO / PALLETIZED AND PACKAGING

Código - Code	00249 - 00250			00251 - 00252		
	a	b	c	a	b	c
Medidas caja (mm) - Box sizes (mm)	428	260	377	587	452	436
Unidades / Caja - Units / Box	1			1		
Volumen / Caja (m³) - Volume / Box (m³)	0,044			0,116		
Peso / Caja (Kg) - Weight / Box (Kg)	2,4			4,47 - 5		
Medidas palet (mm) - Pallet sizes (mm)	a	b	c	a	b	c
	1000	1200	2150	1000	1200	2300
Unidades / Palet - Units / Pallet	54			20		
Volumen / Palet (m³) - Volume / Pallet (m³)	2,58			2,76		
Peso / Palet (Kg) - Weight / Pallet (Kg)	144,6			97,96 - 108,56		

► CAJA / BOX

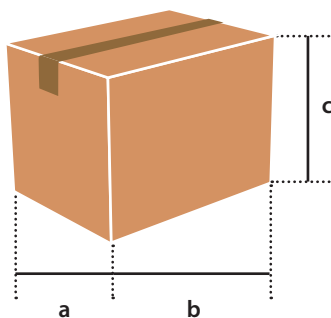

► PALET / PALLET

